

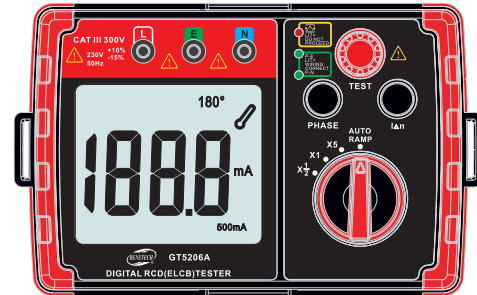

MODEL: GT5206A

## DIGITAL RCD(ELCB)TESTER Instruction Manual



Standard: Q/GMY 009-2017  
Version: 5206A-EN-0

# CONTENTS

## 1. Notice use before

- Check-up------(01)
- Safety warning -----(02)
- Feature and function-----(05)
- Diagram of the unit -----(07)
- LCD display -----(08)
- Specifications ----- (09)

## 2. Operation Instructions

- measurement------(10)

## 3. Other items

- Maintenance and warranty------(13)

## 1. Notice use before

### Check-up

Carefully unpack your kit and ensure that you have the following items. In case that any items is missing or if you find any mismatch or damage, promptly contact your dealer.



- Digital Rcd(elcb) Tester-----1pcs
- Three plug test lead-----1pcs
- User's manual-----1pcs
- Strap-----1pcs
- Cloth bag -----1pcs



## Safety warning

In order to use this instrument correctly, please read this manual carefully before use. This manual contains warning information and safety regulations. When using this instrument, please strictly observe it to ensure operation safety of users and the instrument.

### Note:

1. Before using this instrument, please read and understand contents included in this manual.
2. The instrument must be used in strict accordance with test procedures described in this manual.
3. Be sure to understand the safety aspects in this manual in detail.
4. This instrument must be operated by qualified and qualified technician, and use under conditions specified in this manual.
5. The company is not responsible for equipment damage caused by improper use or violation of safety operation regulations of this manual.

The safety symbol “” has three implications in this manual. Users should pay special attention to operation with “” symbol during reading.

-  **DANGER**—indicates that an environment and operation is likely to cause serious or fatal injury.
-  **WARNING**—Indicates that an environment and operation can cause serious or fatal injury.
-  **CAUTION**—Indicates that environment and operation can cause limited injury or damage to the instrument.

### **DANGER**

- RCD test function of this instrument is only applicable to single-phase 230V / 50Hz line (power supply voltage range 195 ~ 253V)
- Before using this instrument, please check test lead carefully. Cracked test lead and exposed metal wire cannot be used, or it may result in serious or fatal injury.
- During testing, do not touch any exposed wires.
- During testing, make sure that your fingers touch test leads under safe conditions.
- After test is completed, please make sure to remove test lead from power supply immediately, do not allow test lead to be connected to power supply for a long time after measurement.
- Do not try to unscrew screws on the back of the machine at any time.





**△ WARNING**

- Due to dangerous voltage in the case during the test, do not open the case of the instrument during the test. If it fails, please have it inspected and repaired by qualified personnel.
- If the instrument displays any abnormal phenomena (such as imperfect display, unexpected test values, case damage, noise during testing, etc.) Please refer to professional for repair before use.
- If your hands are wet before usage, please do not use the instrument.

**△ CAUTION**

- To ensure safety, please use test leads provided by our company instead of other test leads.
- Do not expose the instrument to harsh environments such as the sun, extreme temperatures, and humidity.
- Use a dry cloth to clean the instrument. Do not use a wet cloth, abrasive or solvent to clean it.
- If the instrument is wet, make sure to store it dry.

Implication of relevant icons of this instrument:

	Signs of Danger, warning, and caution		Indicates double insulation or reinforced insulation protection
	Ground		CE meets European Union standards

## Introduction

This instrument is controlled by an intelligent microcontroller chip, with high precision, high reliability and high stability; AUTO RAMP function enables simultaneously testing action time and action current of fault; according to LCD icon prompts, there is an instruction to check whether the wiring is correct; after test is completed, the measurement results are automatically displayed; there are 0 ° and 180 ° phase options, which can detect quickest trigger time; "OL" is displayed for over range; the instrument is equipped with FUSE safety protection and CAT III 300V safety level. The instrument is used for safety measurement in power, manufacturing, smelting, chemical industry, household electricity and other industries, an ideal tool for production, installation, inspection and maintenance of leakage protection switches.

## Functions

- This instrument is only suitable for single-phase 230V / 50Hz (with power supply voltage range)
- **Wiring check:** whether three LED indicators are correct, if two green indicators P-E and P-N are on, and red indicator is not on, then it is correct: the test can only be triggered if the wiring is correct.
- **Phase angle selection:** you can choose to start the test from positive ( $0^\circ$ ) or from half cycle negative ( $180^\circ$ );
- "OL" is displayed for over range: when the test trip action time exceeds the maximum test time, the LCD will display "OL mS"
- **Automatic data holding:** After test is completed, the displayed measurement results are held for a certain period of time;
- **AUTO RAMP test:** The AUTO RAMP test can test tripping current and time simultaneously.
- **Shutdown alarm function:** After 3 minutes of operation, the instrument will let out a shutdown beep alarm;
- **Built-in FUSE security protection;**
- **Power supply:** directly supplied by circuit under test (power supply 230V / 50Hz);

## Name of parts (Figure 1)

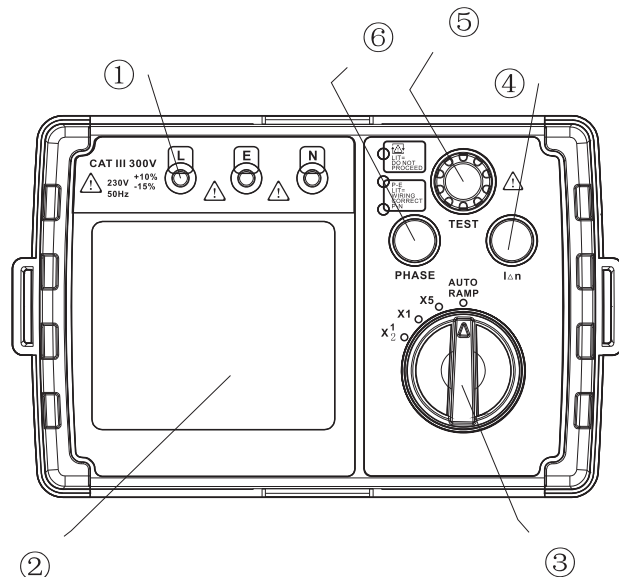

- ① Test port
- ② LCD
- ③ function selection switch
- ④ L Δ n button: trigger current selection button
- ⑤ TEST button: press button to trigger test
- ⑥ PHASE: trigger phase selection button

## LCD Displays (Figure2)

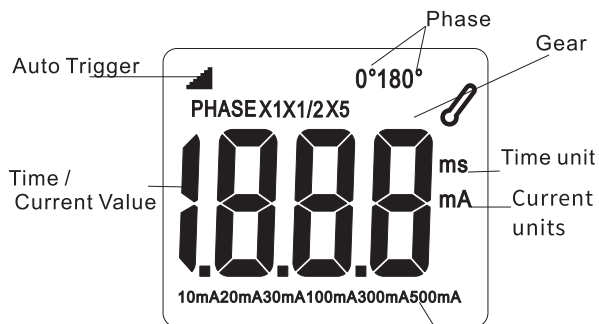

Figure 2 Current of trigger

## Specifications

1. 1 Measurement range and measurement error (temperature: 23 + 5 °C; Humidity: 45% ~ 75% RH; altitude ≤ 2000m:)

### RCD test function:

Functions	Operation voltage (AC)	Rated operating current (LΔn)	Fault action time (MAX)	Accuracy	
				Action current	Action time
X1/2	230V (Error range: -15% ~ +10%)	10/20/30/100/300/500mA	1000ms	Error range: -10% ~ +10%	±0.6% rdg ±8dgt
X1		10/20/30/100/300mA	1000ms		
X5	Frequency: 50Hz	500mA	300ms	Error range: -10% ~ +10%	
AUTO RAMP test		10/20/30mA	1000ms		
		10/20/30/100/300/500mA	(RAMP Increasing step 10%) LΔn 从 20% ~ 110%	Error range: -10% ~ +10%	

### 1.2 Measurement range (function)

X1 / 2 ---- In order not to trigger test, check RCD sensitivity.  
 X1 ----- measurement trigger time.  
 X5 ----- quick trigger time for testing LΔn X5.

AUTO RAMP test --- To test magnitude and trigger time of trigger current.

### 1.3 Application standards:

IEC 61010-1 CAT III 300V Pollution level: secondary

IEC 61557-1, 5

IEC 61010-2-31

### 1.4 Working voltage:

230V / 50Hz (voltage range: 195 ~ 253V)

### 1.5 Working environment:

Temperature: 0 °C ~ 40 °C;

Relative humidity: ≤80% RH

Altitude: ≤2000 meters

### 1.6 Storage conditions:

Temperature: -20 °C ~ 60 °C;

Relative humidity: ≤75% RH

## 2. Operation manual

### Test

#### (1) Connect test leads

Insert ends of test leads into three corresponding ports of the instrument: L to L (fire wire), N to N (zero wire), E to E (ground wire);

#### (2) Wiring inspection

After test lead is connected to the instrument, connect the other end of test lead to road to be tested (230V / 50Hz Power socket), see if indication status of three LED indicators is correct at this time; if two green indicators of P-E and P-N are on, while red indicator is off, the wiring is correct, otherwise

the wiring is incorrect; if P and N are upside down or not well grounded, please unplug test leads immediately, check relevant lines, and then connect them after correction until everything is right.



#### CAUTION

When E and N wirings are reversed for wiring inspection, leakage switch may trip. Please check relevant lines at this time, and then connect them after correction until everything is right are corrected before proceeding to the next test.

#### △ DANGER

If the wiring check is not correct, please do not perform the next test action (press TEST button), otherwise it will cause Incorrect test results or other dangers.

(3) Press L $\Delta$ N button to switch, so that trigger current (L $\Delta$ N) is consistent with standard rated trigger current of RCD (Leakage Switch), and the set trigger current value will be displayed at the bottom of the LCD.

Default setting values: L $\Delta$ N ----- 30mA

0° / 180° ----- 0°

#### (4) test

##### 3.1 Set test parameters

- No trigger test ----- X1 / 2: The maximum test time is 1000ms.
- Trigger test ----- X1: The maximum test time is 1000ms (except 500mA).
- Trigger test ----- X1 (500mA): The maximum test time is 300ms.
- Quick trigger test ---- X5 (only 10, 20, 30mA): The maximum test time is 1000ms.
- AUTO RAMP test ----- Auto Ramp/test maximum test time 300ms, 20% ~ 110% rated trigger current (L $\Delta$ N),

### 3.2 Press TEST button

No trigger test ----- The circuit breaker should not be triggered.

Trigger test ----- The circuit breaker should be triggered.

X5 Quick Test ----- Circuit breaker should be triggered.

AUTO RAMP ----- The circuit breaker should be triggered; with trigger current and trigger time can be displayed at the same time.

### 3.3 Press PHASE (0 ° / 180 °) button to change phase and repeat the steps

(3.2) Decide quickest trigger time.

### 3.4 Change phase again and repeat step (3.2).

### 3.5 After test is completed, remove test leads from power supply immediately.

#### DANGER

1. Ensure that you do not touch any bare metal or bare wires during operation of these tests.
- 2 This instrument will cause related components to heat up during use. If it works continuously for a long time, it may cause damage to instrument or other dangers; therefore, this instrument is not suitable for long-term continuous test of leakage switch production plant assembly line; it is only suitable for precision testing of spot checks.
- 3 Trigger current 300mA / 500mA (high current trigger test) test must be guaranteed one measurement every five minutes.

## 3. Other items

### Maintenance and warranty

4.1 Case cleaning: Alcohol, diluent, etc. have a corrosive effect on the case, especially the window; so when cleaning the case, wipe it gently with dry towel. Be sure to avoid getting the instrument wet.

#### 4.2 Maintenance

If any following problem occurs, please contact aftersales service center of our company's marketing department or agencies:

- A. The instrument case is damaged or the device is damaged.
- B. LCD is abnormal.
- C. During normal use, unexpected data is measured.
- D. button operation failure or confusion.
- E. Noise appears during test.

#### Special statement:

- a.Used batteries must be disposed of in accordance with local laws or regulations
- b.The company is not liable for any derivative results of using this product.
- c.The company reserves the right to update and modify the design specifications and content of this product, and it is subject to change without notice!